

4100 / 4200 / 5100

profile

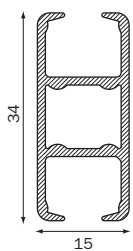

4100
405 gr/m

bending

radius
R 15 *) (1015)
R 20 (1015)
R 30 (1015)
R >80 (1018)

filler position

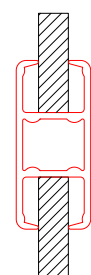

profile

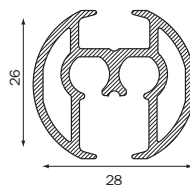

5100
522 gr/m

bending

radius
R 15 *) (1015)
R 25 (1015)
R >100 (1018)

filler position

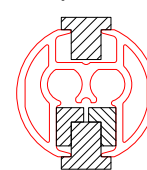

L-shaped fillers
only for cord operated systems

*) Bending: Minimum radius 15 cm. Larger radius (20, 25, 30 cm) strongly recommended for smoother curtain movement in bends.

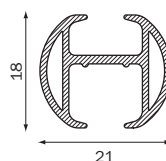

4200
274 gr/m

radius
R 15 *) (1015)
R 25 (1015)
R >100 (1018)

filler position

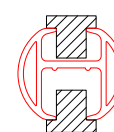

*) Bending: Minimum radius 10 cm. Larger radius (15 cm) strongly recommended for smoother curtain movement in bends.

Mounting

ceiling and wall mounting

4100, 4200 & 5100

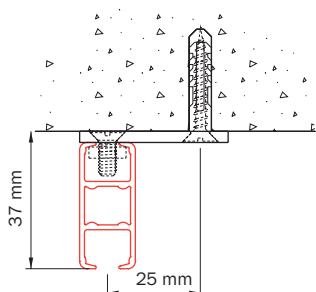

ceiling mounting 4100
with ceiling bracket 4135

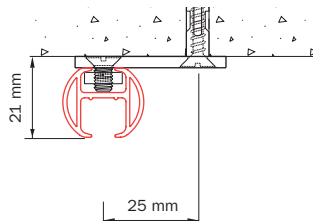

ceiling mounting 4200
with ceiling bracket 5153

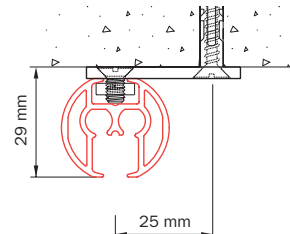

ceiling mounting 5100
with ceiling bracket 5135

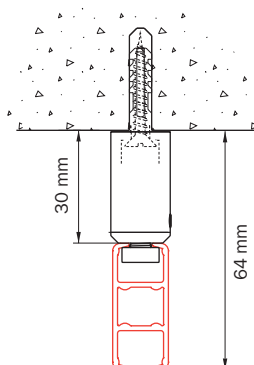

ceiling mounting 4100 with
suspension hanger 4254

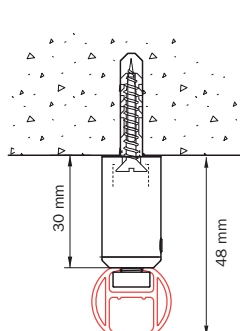

ceiling mounting 4200 with
suspension hanger 4254

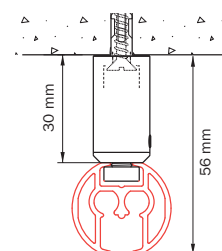

ceiling mounting 5100 with
suspension hanger 4254

Mounting

ceiling and wall mounting

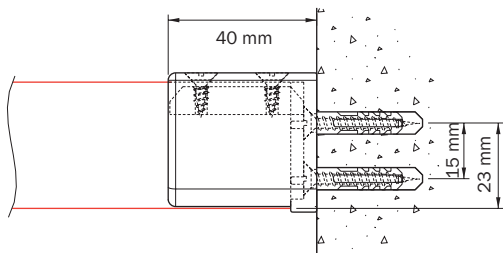

wall mounting 4100 with wall bracket 4149

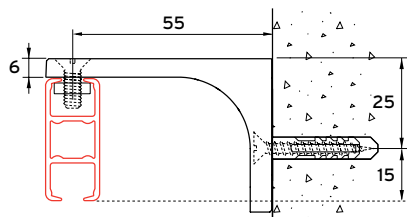

wall mounting 4100 with wall bracket 4140

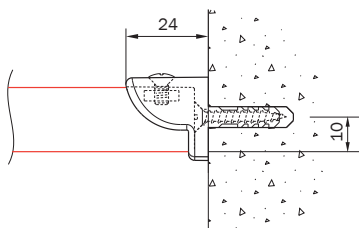

wall mounting 4200 with wall bracket 24249

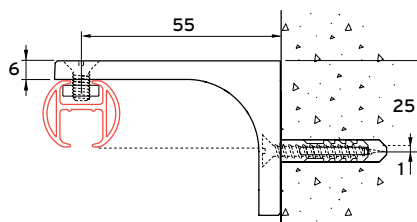

wall mounting 4200 with wall bracket 5140

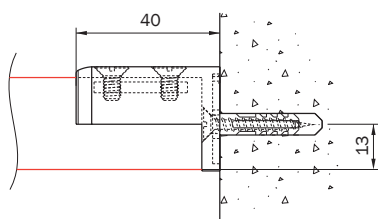

wall mounting 5100 with wall bracket 5149

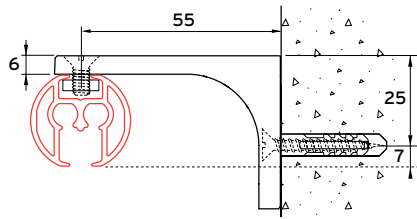

wall mounting 5100 with wall bracket 5140

Suspension hangers

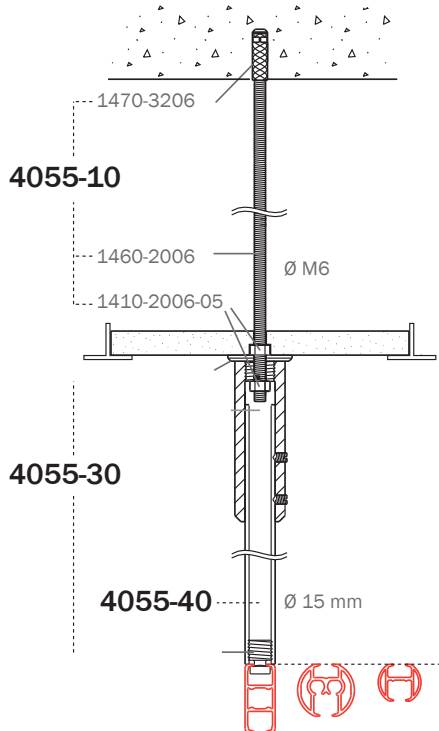

- ceiling mounting 4100, 5100 or 4200:
threaded rod set 4055-10, suspension hanger tube 4055-40 and with mounting set 4055-30.

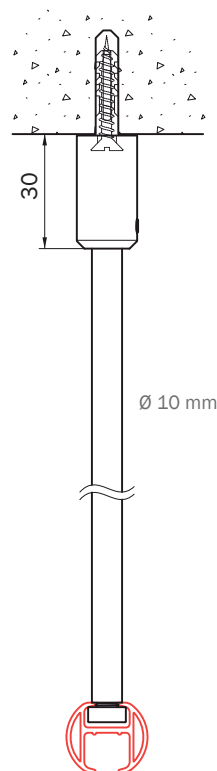

ceiling mounting with 4255

Application examples

standard shower rail situations and suspension hanger positions

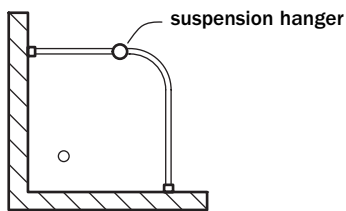

L-shaped (shower)

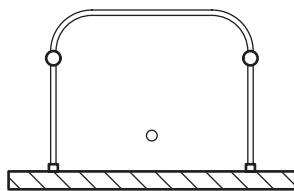

U-shaped (shower)

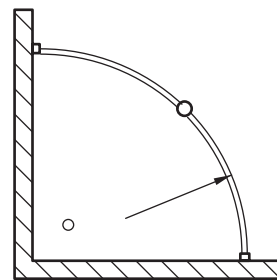

special (for example corner baths)

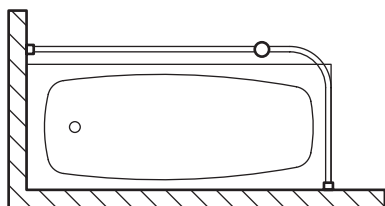

L-shaped (bath)

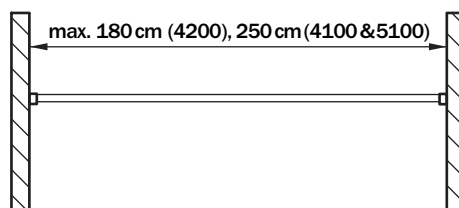

straight rail

perpendicular connections in 4100 and 5100

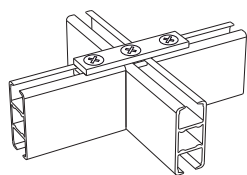

connection bracket 4130

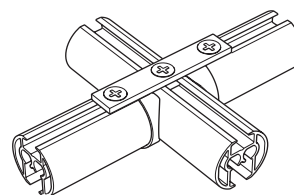

connection bracket 5130

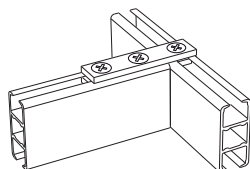

connection bracket 4130 for T junction

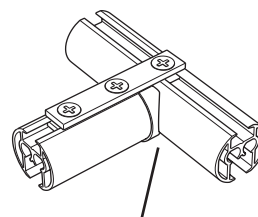

connection bracket 5130 for T junction

hollow end cap 5153-20

G-standard 4100, 4200 & 5100

