

# 2500, 2600

HAND DRAWN  
SMALL CHANNEL

# 2500, 2600

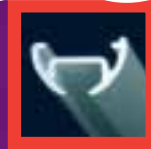

**G-RAIL<sup>®</sup>**

ALUMINIUM RAIL

> *by Goelst*



These elegant profiles are suitable for sheers and light weight curtains and have the advantage of secret fixing.  
Both profiles 2500 and 2600 can be forward and reverse bent making them ideal for use in bay windows.

Colours 2500: White RAL 9010, natural.

Colours 2600: White RAL 9010, natural, gold.

Special colours on request.

# 2500, 2600 > Attr rounded profile concealed fixi

HAND DRAWN  
SMALL CHANNEL  
# 2500, 2600



## Installation

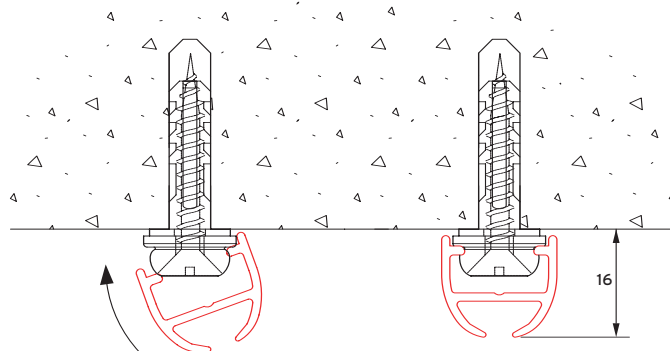

ceiling fixing (profile 2500) with button clip 2254 and washer 2649

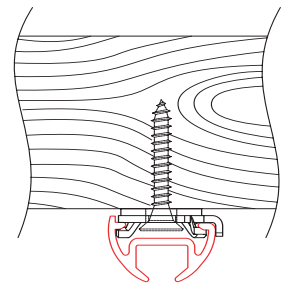

ceiling fixing (profile 2600) with clamp 2650, washer 2649 and special screw 2614

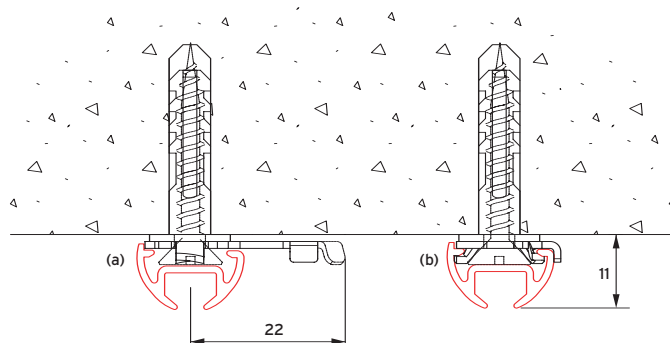

ceiling fixing (profile 2600) with clamp 2650 (incl. washer 2649).

(a) Maintain a 22mm gap from the wall to allow rotation of the fixing clamp.

(b) after turning and securing the clamp.

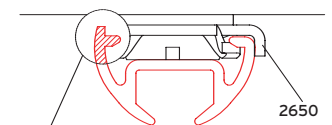

the high side of profile 2600 is positioned to the front

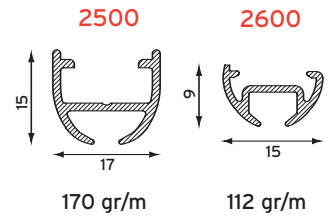
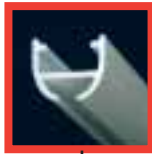

## Specification Guide

### G-Standard (bracket fixing guide)

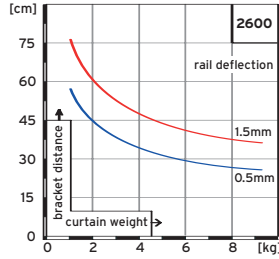
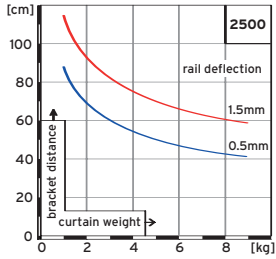

# active s offering ng.

#### 2500

##### Material:

Aluminium 606035-T6-F22. (Higher specification than DIN 1725). Shape and size tolerances are in accordance with DIN 17615. Natural silver anodised in accordance with the Qualanod standard. White RAL 9010 powder coated in accordance with the Qualicoat standard.

Special colours on request. Profile weight 2500: 170 gr/m.

##### Accessories:

Gliders 2010 at 10 to 16 per metre with 2 end stops 2001 per length.

##### Installation:

Ceiling fixing with button clip 2254 using 4.0 mm countersunk screw. Include washer 2649 when fixing to uneven ceilings.

Bracket distance (cm) according to G-Standard or the following table.

	light	medium	heavy (curtain)
2500	70	55	40

##### Bending:

Minimum radius 10 cm. Bending machine 1012 or 1015.

#### 2600

##### Material:

Aluminium 606035-T6-F22. (Higher specification than DIN 1725). Shape and size tolerances are in accordance with DIN 17615. Natural silver or gold anodised in accordance with the Qualanod standard.

White RAL 9010 powder coated in accordance with the Qualicoat standard.

Special colours on request. Profile weight 2600: 112 gr/m.

##### Accessories:

Gliders 2010 at 10 to 16 per metre with 2 end stops 2001 and 2 end covers 2653 per length.

##### Installation:

Ceiling fixing to timber using fixing clamp 2650 (Including washer) and screw 2614 (19mm). Ceiling fixing to concrete using fixing clamp 2650 (including washer), wall plug and standard countersunk screw.

Bracket distance (cm) according to G-Standard or the following table.

	light	medium	heavy (curtain)
2600	45	35	25

##### Bending:

Minimum radius 7,5 cm. Bending machine 1012 or 1015.

### Product example

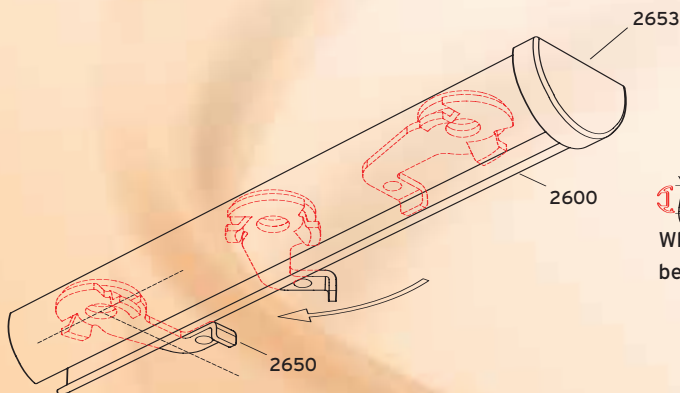













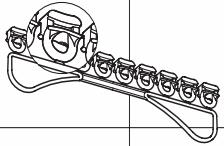

Use fixing clamp 2650 for ceiling mounting profile 2600

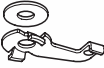

When installing a curved rail 2600, place a fixing clamp both before and after the bend.

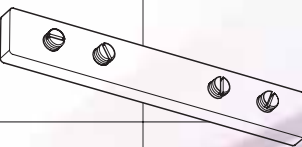

# Components

Product design and specification changes reserved.

CURTAIN TRANSPORT			
	<b>2001</b> end stop colours: B - G - W		<b>2022</b> curtain hook
	<b>2001-A</b> end stop with eye (metal)		<b>2025</b> glider 2010 with hook 2023
	<b>2003</b> spring stop	<b>CEILING FIXING</b>	
	<b>2010</b> glider (on strip) colours: B - G - W		<b>2254</b> button clip (for 2500)
	<b>2012-10</b> click glider		<b>2649</b> washer for use with 2254 for uneven ceilings
	<b>2012-40</b> click glider transversed		<b>2650</b> fixing clamp for 2600 incl. washer 2649
	<b>2012-50</b> click glider transversed with hook		<b>2614</b> screw for use with fixing clamp 2650
	<b>2020</b> double hook	<b>ACCESSORIES</b>	
	<b>2021</b> G-hook		<b>2552</b> connecting bridge (for 2500)
			<b>2652</b> connecting bridge (for 2600)
			<b>2653</b> end cap (for 2600) colours: G - GR - W

**HAND DRAWN  
SMALL CHANNEL**  
# 2500, 2600

B = Brown  
G = Gold  
GR = Grey  
W = White

 = Standard item  
 = registered design

**G-RAIL®**

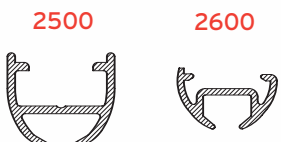

Space for dealer address

10/2004